

PHC 40B-1X5MTR

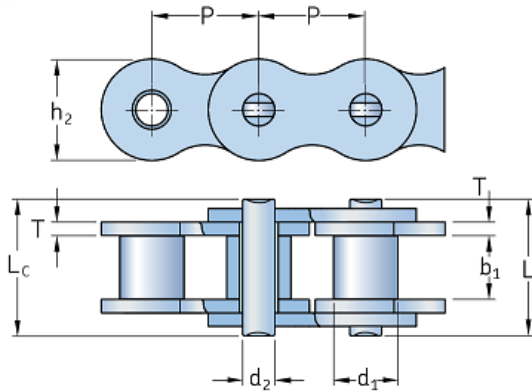

Pitch P (mm)	63.5
Pitch P (in)	2.5
Roller diameter d1 max (mm)	39.37
Roller diameter d1 max (in)	1.55
Width between inner plates b1 min (mm)	38.1
Width between inner plates b1 min (in)	1.5
Pin diameter d2 max (mm)	22.89
Pin diameter d2 max (in)	0.9
Plate height h2 max (mm)	52.96
Plate height h2 max (in)	2.09
Plate thickness T max (mm)	8
Plate thickness T max (in)	0.31
Weight (kg/m)	16.35
Weight (lbs/ft)	10.99